

SW 41 Ti ROTOR



**Used In Beckman Coulter
Class H, R, and S
Preparative Ultracentrifuges**



SAFETY NOTICE

This safety notice summarizes information basic to the safe use of the rotor described in this manual. The international symbol displayed above is a reminder to the user that all safety instructions should be read and understood before operation or maintenance of this equipment is attempted. When you see the symbol on other pages throughout this publication, pay special attention to the specific safety information presented. Observance of safety precautions will also help to avoid actions that could damage or adversely affect the performance of the rotor. This rotor was developed, manufactured, and tested for safety and reliability as part of a Beckman Coulter ultracentrifuge/rotor system. Its safety or reliability cannot be assured if used in a centrifuge not of Beckman Coulter's manufacture or in a Beckman Coulter ultracentrifuge that has been modified without Beckman Coulter's approval.



Handle body fluids with care because they can transmit disease. No known test offers complete assurance that such fluids are free of micro-organisms. Some of the most virulent—Hepatitis (B and C) viruses, and HIV (I–V), atypical mycobacteria, and certain systemic fungi—further emphasize the need for aerosol protection. Handle other infectious samples according to good laboratory procedures and methods to prevent spread of disease. Because spills may generate aerosols, observe proper safety precautions for aerosol containment. Do not run toxic, pathogenic, or radioactive materials in this rotor without taking appropriate safety precautions. Biosafe containment should be used when Risk Group II materials (as identified in the World Health Organization *Laboratory Biosafety Manual*) are handled; materials of a higher group require more than one level of protection.



The rotor and accessories are not designed for use with materials capable of developing flammable or explosive vapors. Do not centrifuge such materials in nor handle or store them near the ultracentrifuge.



Although rotor components and accessories made by other manufacturers may fit in the SW 41 Ti rotor, their safety in this rotor cannot be ascertained by Beckman Coulter. Use of other manufacturers' components or accessories in the SW 41 Ti rotor may void the rotor warranty and should be prohibited by your laboratory safety officer. Only the components and accessories listed in this publication should be used in this rotor.



Hook all six buckets, loaded or empty, to the rotor for every run. Make sure that filled containers are loaded symmetrically into the rotor and that opposing tubes are filled to the same level with liquid of the same density. Make sure that buckets containing Quick-Seal tubes have the proper floating spacers inserted (if applicable) before installing the bucket cap.



If disassembly reveals evidence of leakage, you should assume that some fluid escaped the rotor. Apply appropriate decontamination procedures to the centrifuge and accessories.



Never exceed the maximum rated speed of the rotor and labware in use. Refer to the section on RUN SPEEDS, and derate the run speed as appropriate.



Do not use sharp tools on the rotor that could cause scratches in the rotor surface. Corrosion begins in scratches and may open fissures in the rotor with continued use.

SW 41 Ti Rotor

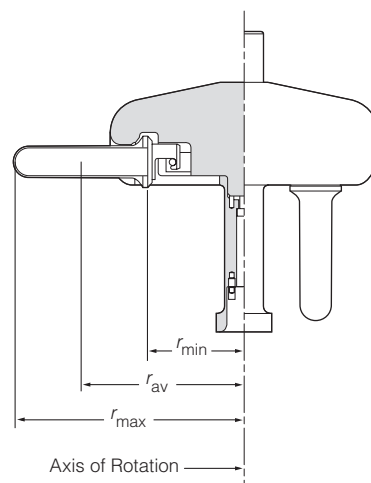

U.S. Pat. No. 3,393,864;
 Japanese Pat. No. 739,613;
 British Pat. No. 1,145,005;
 German Pat. No. 1,598,174.

SPECIFICATIONS

Maximum speed	41 000 rpm
Density rating at maximum speed	1.2 g/mL
Relative Centrifugal Field* at maximum speed	
At r_{max} (153.1 mm)	288 000 × g
At r_{av} (110.2 mm)	207 000 × g
At r_{min} (67.4 mm)	127 000 × g
k factor at maximum speed	124
k' factors at maximum speed (5 to 20% sucrose gradient; 5°C)	
When particle density = 1.3 g/mL	335
When particle density = 1.5 g/mL	307
When particle density = 1.7 g/mL	295
Conditions requiring speed reductions	see RUN SPEEDS
Number of buckets	6
Available tubes	see Table 1
Nominal tube dimensions (largest tube)	14 × 89 mm
Nominal tube capacity (largest tube)	13.2 mL
Nominal rotor capacity	79.2 mL
Approximate acceleration time to maximum speed (fully loaded)	
in an Optima XL ultracentrifuge	7 min
in an L8M ultracentrifuge	6 min
Approximate deceleration time from maximum speed (fully loaded)	
in an Optima XL ultracentrifuge	7 min
in an L8M ultracentrifuge	5 min
Weight of fully loaded rotor	6.4 kg (14 lb)
Rotor material	titanium

* Relative Centrifugal Field (RCF) is the ratio of the centrifugal acceleration at a specified radius and speed ($r\omega^2$) to the standard acceleration of gravity (g) according to the following formula:

$$RCF = \frac{r\omega^2}{g}$$

where r is the radius in millimeters, ω is the angular velocity in radians per second ($2\pi \text{ RPM} / 60$), and g is the standard acceleration of gravity (9807 mm/s^2). After substitution:

$$RCF = 1.12 r \left(\frac{\text{RPM}}{1000} \right)^2$$

DESCRIPTION

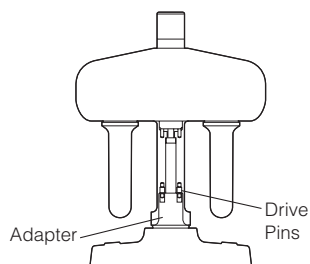

This Beckman Coulter rotor has been manufactured in an NSAI-registered ISO 9001 or 9002 facility for use with the appropriately classified Beckman Coulter ultracentrifuge.

The SW 41 Ti, rated for 41 000 rpm, is a swinging bucket rotor designed to centrifuge up to six tubes. Used in Beckman Coulter class H, R, and S preparative ultracentrifuges, the rotor develops centrifugal forces for the separation and purification of small particles. Typical applications include separation of RNA, proteins, and subcellular particles in solution using rate zonal centrifugation. Approximate sample volume per tube is 0.5 mL, with a gradient volume of about 12.5 mL.

The rotor body and buckets are made of titanium and finished with black polyurethane paint. *Do not interchange these black buckets with the SW 40 Ti red buckets.* Bucket caps are anodized aluminum. The bucket and cap assemblies hook over the crossbar of the rotor hanger mechanism. Gaskets, made of Buna N rubber, between each bucket and bucket cap maintain atmospheric pressure inside the buckets during centrifugation.

NOTE

On some swinging bucket rotors a solid film lubricant coating is added to the bucket flange where the bucket contacts the rotor body. The purpose of the coating, which is a dull gray in color, is to minimize friction and enable the bucket to swing into the rotor bucket pocket more smoothly. With use and handling, all or part of this coating may wear off; this should not affect the rotor performance, as the bucket swing-up will wear in with use.

Drive pins in the rotor bottom prevent the rotor from slipping on the ultracentrifuge drive hub during acceleration and deceleration. Two indentations on the sides of the rotor adapter indicate their location.

For overspeed protection, a Beckman Coulter ultracentrifuge equipped with a photoelectric detector will monitor the overspeed disk on the adapter bottom and shut down the run if a speed exceeding the maximum allowable speed is detected.

Refer to the Warranty at the back of this manual for warranty information.

PREPARATION AND USE

Specific information about the SW 41 Ti rotor is given here. Information common to this and other rotors is contained in Rotors and Tubes for Preparative Ultracentrifuges (publication LR-IM), which should be used together with this manual for complete rotor and accessory operation. Rotors and Tubes is included in the literature package with this rotor manual.

NOTE

Although rotor components and accessories made by other manufacturers may fit in the SW 41 Ti rotor, their safety in this rotor cannot be ascertained by Beckman Coulter. Use of other manufacturers' components or accessories in the SW 41 Ti rotor may void the rotor warranty and should be prohibited by your laboratory safety officer. Only the components and accessories listed in this publication should be used in this rotor.

PRERUN SAFETY CHECKS



Read the Safety Notice page at the front of this manual before using the rotor.

1. Make sure that the rotor, buckets, and caps are clean and show no signs of corrosion or cracking.
2. Make sure that the rotor is equipped with the correct overspeed disk. If the disk is missing or damaged, replace it according to the instructions in *Rotors and Tubes*.
3. Check the chemical compatibilities of all materials used (refer to Appendix A in *Rotors and Tubes*).
4. Verify that the tubes being used are listed in Table 1.

ROTOR PREPARATION

For runs at other than room temperature, refrigerate or warm the rotor beforehand for fast equilibration.

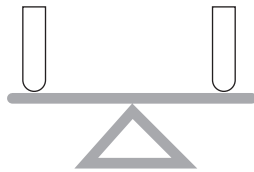
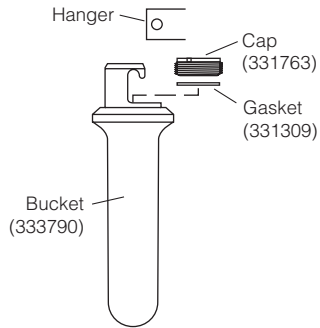

1. Load the filled containers into the buckets (see page 8 for tube and accessory information). Complete loading by placing the correct floating spacers (if required) over the tubes.
2. Ensure that bucket gaskets are lightly but evenly coated with silicone vacuum grease. Do not run a bucket without a gasket, as the bucket will leak.
3. Be sure that metal threads in the bucket caps are clean and lightly but evenly lubricated with Spinkote™ lubricant. Put bucket caps on the buckets and use a screwdriver to screw the caps into the buckets until there is metal-to-metal contact.
4. *Hook all buckets, loaded or empty, to the rotor.* If fewer than six tubes are being run, they must be arranged symmetrically in the rotor (see Figure 1). Opposing tubes must be filled to the same level with liquid of the same density.

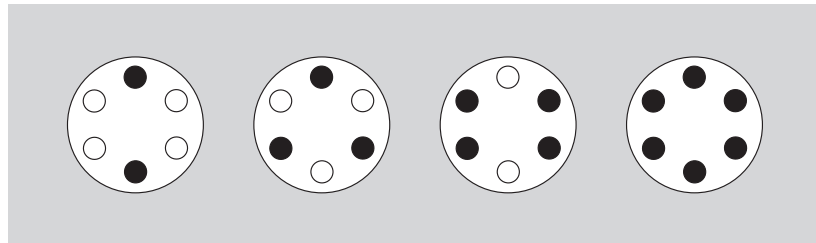
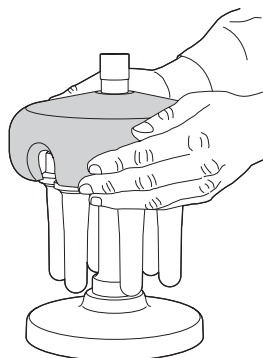

Figure 1. Arranging Tubes in the Rotor. Two, three, four, or six tubes can be centrifuged per run if they are arranged in the rotor as shown. All buckets must be attached to the rotor, whether loaded or empty.

OPERATION



Refer to Rotors and Tubes for information on installing swinging bucket rotors.

1. To install the rotor, carefully lift it with both hands—*do not lift the rotor by the adapter*—and place it on the drive hub. Make sure that the rotor pins are perpendicular to the drive hub pins. The pins must not rest on top of each other; turn the rotor to the right (clockwise) by hand to check for proper installation.

NOTE

The aluminum handle supplied with the SW 41 Ti rotor is *not interchangeable* with similar handles supplied with other rotors.

2. Refer to the instrument instruction manual for ultracentrifuge operation. In Model L2 ultracentrifuges, use the top stabilizer level for this rotor.
3. For additional operating information, see the following:
 - RUN TIMES, page 10, for using k factors to adjust run durations
 - RUN SPEEDS, page 11, for information about speed limitations
 - SELECTING CsCl GRADIENTS, page 13, for methods to avoid CsCl precipitation during centrifugation

REMOVAL AND SAMPLE RECOVERY



CAUTION

If disassembly reveals evidence of leakage, you should assume that some fluid escaped the rotor. Apply appropriate decontamination procedures to the centrifuge and accessories.

1. Remove the rotor from the instrument by lifting it straight up and off the drive hub.
2. Set the rotor on the rotor stand and carefully remove the buckets.

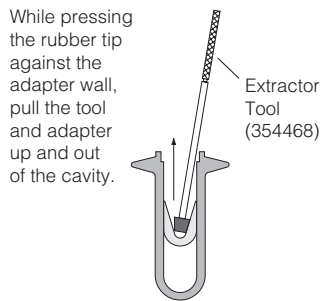

- Remove the bucket caps and use the appropriate removal tool (listed in the SUPPLY LIST) to remove the spacers and tubes. If floating spacers were used, remove them with the threaded end of the floating spacer removal tool (338765).

NOTE

If the conical-shaped adapters that support konical tubes are difficult to remove after centrifugation, an extractor tool (354468) is available to facilitate removal.

TUBES AND ACCESSORIES

The SW 41 Ti rotor uses tubes and accessories listed in Table 1. Be sure to use only those items listed, and to observe the maximum speed limits shown. Refer to Appendix A in *Rotors and Tubes* for information on the chemical resistances of tube and accessory materials.

Temperature Limits

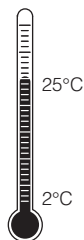

- Plastic tubes have been centrifuge tested for use at temperatures between 2 and 25°C. For centrifugation at other temperatures, pretest tubes under anticipated run conditions.
- If plastic containers are frozen before use, make sure that they are thawed to at least 2°C prior to centrifugation.

Quick-Seal® Tubes

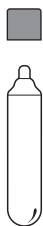

Quick-Seal tubes must be sealed prior to centrifugation. These tubes are heat sealed and do not need caps; however, spacers are required on top of the tubes when they are loaded into the rotor buckets.

- Fill Quick-Seal tubes leaving a *small* bubble of air at the base of the neck. Do not leave a large air space—too much air can cause excessive tube deformation.
- Refer to *Rotors and Tubes* for detailed information on the use and care of Quick-Seal tubes.

Table 1. Beckman Coulter Tubes for the SW 41 Ti Rotor. Use only the items listed here.

Tube			Required Accessory		Max Speed/ RCF/ k Factor
Dimensions and Volume	Description	Part Number	Description	Part Number	
14 x 89 mm 13.2 mL	Ultra Clear	344059 (pkg/50)	none	—	41 000 rpm 288 000 x g 124
14 x 89 mm 13.2 mL	thinwall polyallomer	331372 (pkg/50)	none	—	41 000 rpm 288 000 x g 124
14 x 89 mm 10.0 mL	konical open-top polyallomer	358120 (pkg/50)	adapter	358154	41 000 rpm 288 000 x g 124
14 x 89 mm 8.0 mL	Quick-Seal konical, polyallomer	358649 (pkg/50)	adapter	358154	41 000 rpm 288 000 x g 108
			Noryl* floating spacer	355534	
14 x 47 mm 5.9 mL	Quick-Seal polyallomer	355537 (pkg/50)	Noryl floating spacer	355534	41 000 rpm 288 000 x g 55
14 x 48 mm 4.0 mL	Quick-Seal konical, polyallomer	355870 (pkg/50)	adapter	358154	41 000 rpm 288 000 x g 56
			Noryl floating spacer	355534	
14 x 25 mm 3.5 mL	Quick-Seal konical, polyallomer	358649 (pkg/50)	adapter	358154	41 000 rpm 288 000 x g 27
			Noryl floating spacer	355534	

*Noryl is a registered trademark of GE Plastics.

Some of the tubes listed in Table 1 are part of the *g*-Max™ system. The *g*-Max system uses a combination of small bell-top Quick-Seal tubes and floating spacers (also called *g*-Max spacers). This means that you can run the shorter tubes listed in the table in the SW 41 Ti rotor without reduction in *g* force. Additional information about the *g*-Max system is available in publication DS-709.

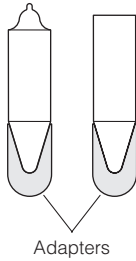

konical™ Tubes

Polyallomer *konical* tubes, used to optimize pelleting separations, have a conical tip that concentrates the pellet in the narrow end of the tube. The narrow bottom also reduces the tube's nominal volume and minimizes gradient material requirement. The *konical* tubes come in both open-top and Quick-Seal tube designs. Conical cavity adapters hold the tubes in the rotor buckets.

Polyallomer and Ultra-Clear® Open-Top Tubes

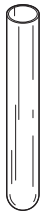

Polyallomer and Ultra-Clear open-top tubes should be filled as full as possible (2 or 3 mm from the tube top) for tube support. If necessary, float mineral oil (or some other low-density, immiscible liquid) on top of the tube contents to fill the tube to its maximum volume. (Do not use an oil overlay in Ultra-Clear tubes.) All opposing tubes for a run must be filled to the same level with liquid of the same density.

RUN TIMES

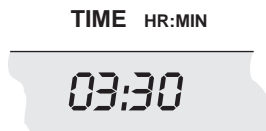

The *k* factor of the rotor is a measure of the rotor's pelleting efficiency. (Beckman Coulter has calculated the *k* factors for all of its preparative rotors at maximum rated speed and using full tubes.) The *k* factor is calculated from the formula:

$$k = \frac{\ln(r_{\max}/r_{\min})}{\omega^2} \times \frac{10^{13}}{3600} \quad (1)$$

where ω is the angular velocity of the rotor in radians per second ($\omega = 0.105 \times \text{rpm}$), r_{\max} is the maximum radius, and r_{\min} is the minimum radius.

After substitution:

$$k = \frac{(2.533 \times 10^{11}) \ln(r_{\max}/r_{\min})}{\text{rpm}^2} \quad (2)$$

Use the k factor in the following equation to estimate the run time t (in hours) required to pellet particles of known sedimentation coefficient s (in Svedberg units, S).

$$t = \frac{k}{s} \quad (3)$$

Run times can be estimated for centrifugation at less than maximum speed by adjusting the k factor as follows:

$$k_{\text{adj}} = k \left(\frac{41\,000}{\text{actual run speed}} \right)^2 \quad (4)$$

Run times can also be estimated from data established in prior experiments if the k factor of the previous rotor is known. For any two rotors, a and b:

$$\frac{t_a}{t_b} = \frac{k_a}{k_b} \quad (5)$$

For more information on k factors see *Use of k Factor for Estimating Run Times from Previously Established Run Conditions* (publication DS-719).

RUN SPEEDS



The centrifugal force at a given radius in a rotor is a function of speed. Comparisons of forces between different rotors are made by comparing the rotors' relative centrifugal fields (RCF). When rotational speed is adjusted so that identical samples are subjected to the same RCF in two different rotors, the samples are subjected to the same force. The RCF at a number of rotor speeds is provided in Table 2.

Do not select rotational speeds in excess of 41 000 rpm. In addition, speeds must be reduced under the following circumstances:

*Table 2. Relative Centrifugal Fields for the SW 41 Ti Rotor.
 Entries in this table are calculated from the formula
 $RCF = 1.12r (RPM/1000)^2$
 and then rounded to three significant digits.*

Rotor Speed (rpm)	Relative Centrifugal Field (× g)			k Factor*
	At r_{max} (153.1 mm)	At r_{av} (110.2 mm)	At r_{min} (67.4 mm)	
41 000	288 000	207 000	127 000	124
40 000	274 000	197 000	121 000	130
36 000	222 000	160 000	97 800	160
35 000	210 000	151 000	92 500	170
30 000	154 000	111 000	67 900	231
25 000	107 000	77 100	47 200	333
20 000	69 000	49 400	30 200	520
15 000	38 600	27 800	17 000	924
10 000	17 200	12 300	7 550	2078

*Calculated for all Beckman Coulter preparative rotors as a measure of the rotor's relative pelleting efficiency, in water at 20°C.

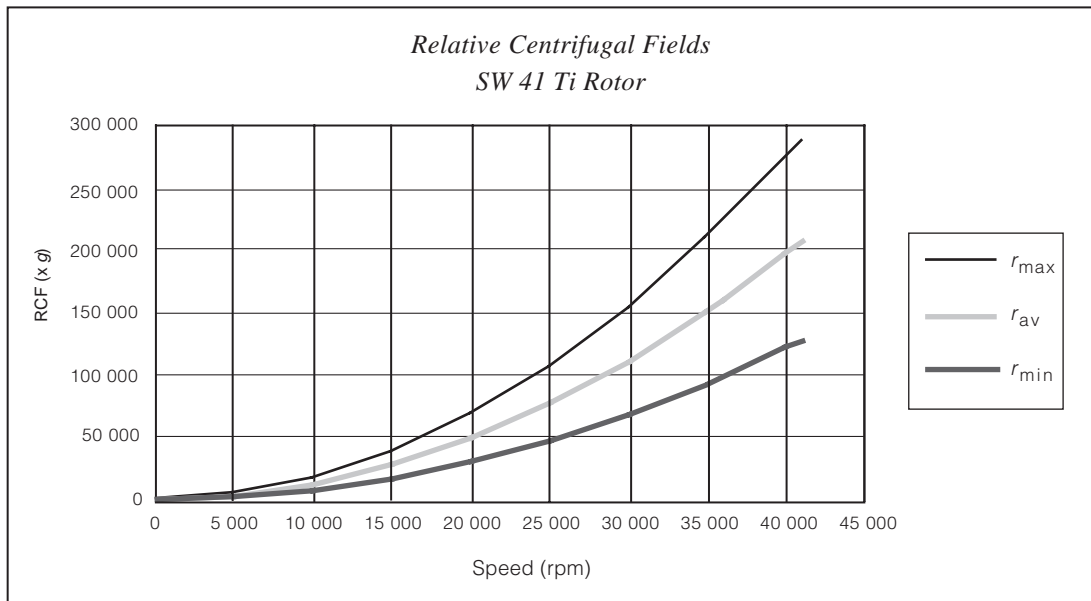

1. If nonprecipitating solutions more dense than 1.2 g/mL are centrifuged, reduce the maximum allowable run speed according to the following equation:

$$\text{reduced maximum speed} = (41\,000 \text{ rpm}) \sqrt{\frac{1.2 \text{ g/mL}}{\rho}} \quad (6)$$

where ρ is the density of the tube contents. This speed reduction will protect the rotor from excessive stresses due to the added tube load.

2. *Further speed limits must be imposed* when CsCl or other self-forming-gradient salts are centrifuged, as equation (6) does not predict concentration limits/speeds that are required to avoid precipitation of salt crystals. Solid CsCl has a density of 4 g/mL, and if precipitated during centrifugation may cause rotor failure. Figures 2 and 3, together with the description and examples below, show how to reduce run speeds when using CsCl gradients.

SELECTING CsCl GRADIENTS



Rotor speed is used to control the slope of a CsCl density gradient, and must be limited so that CsCl precipitation is avoided. Speed and density combinations that intersect on or below the curves in Figure 3 ensure that CsCl will not precipitate during centrifugation in the SW 41 Ti rotor. Curves are provided at two temperatures: 20°C (black curves) and 4°C (gray curves). Curves in Figures 2 and 3 are provided up to the maximum rated speed of the rotor.

NOTE

The curves in Figures 2 and 3 are for solutions of CsCl salt dissolved in distilled water only. If other salts are present in significant concentrations, the overall CsCl concentration may need to be reduced.

The reference curves in Figure 3 show gradient distribution at equilibrium. Each curve in Figure 3 is within the density limits allowed for the SW 41 Ti rotor: each curve was generated for a single run speed using the maximum allowable homogeneous CsCl densities (one for each fill level) that avoid precipitation at that speed. (The gradients in Figure 3 can be generated from step or linear gradients,

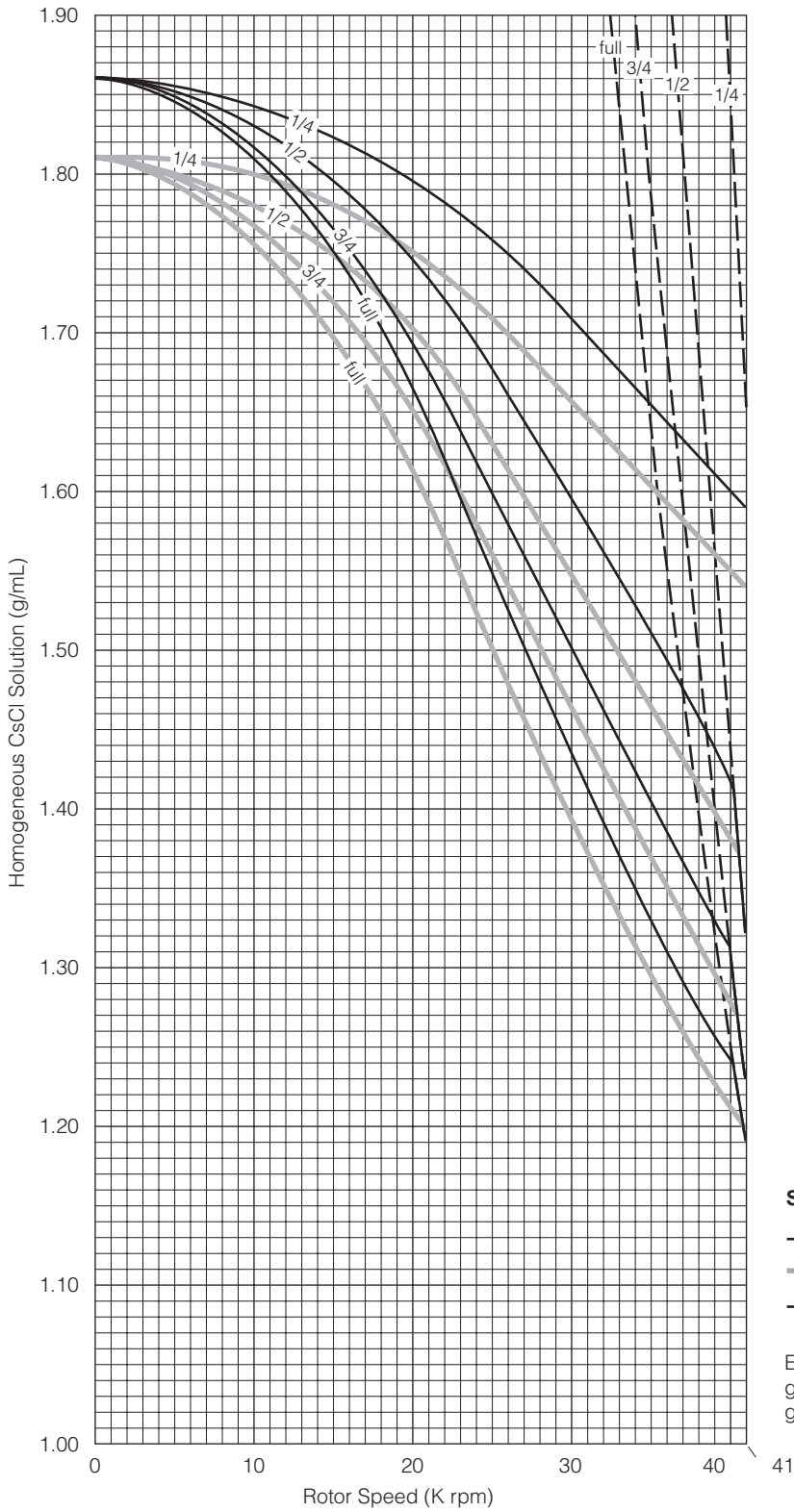

Figure 2. Precipitation Curves for the SW 41 Ti Rotor. Using combinations of rotor speeds and homogeneous CsCl solution densities that intersect on or below these curves ensures that CsCl will not precipitate during centrifugation. The dashed lines are representations of equation (6), and are shown here to illustrate the inability of that equation to predict CsCl precipitation.

SW 41 Ti ROTOR

- = 20° C
- = 4° C
- - - = square-root formula

Each square on the grid represents 0.010 g/mL or 1000 rpm.

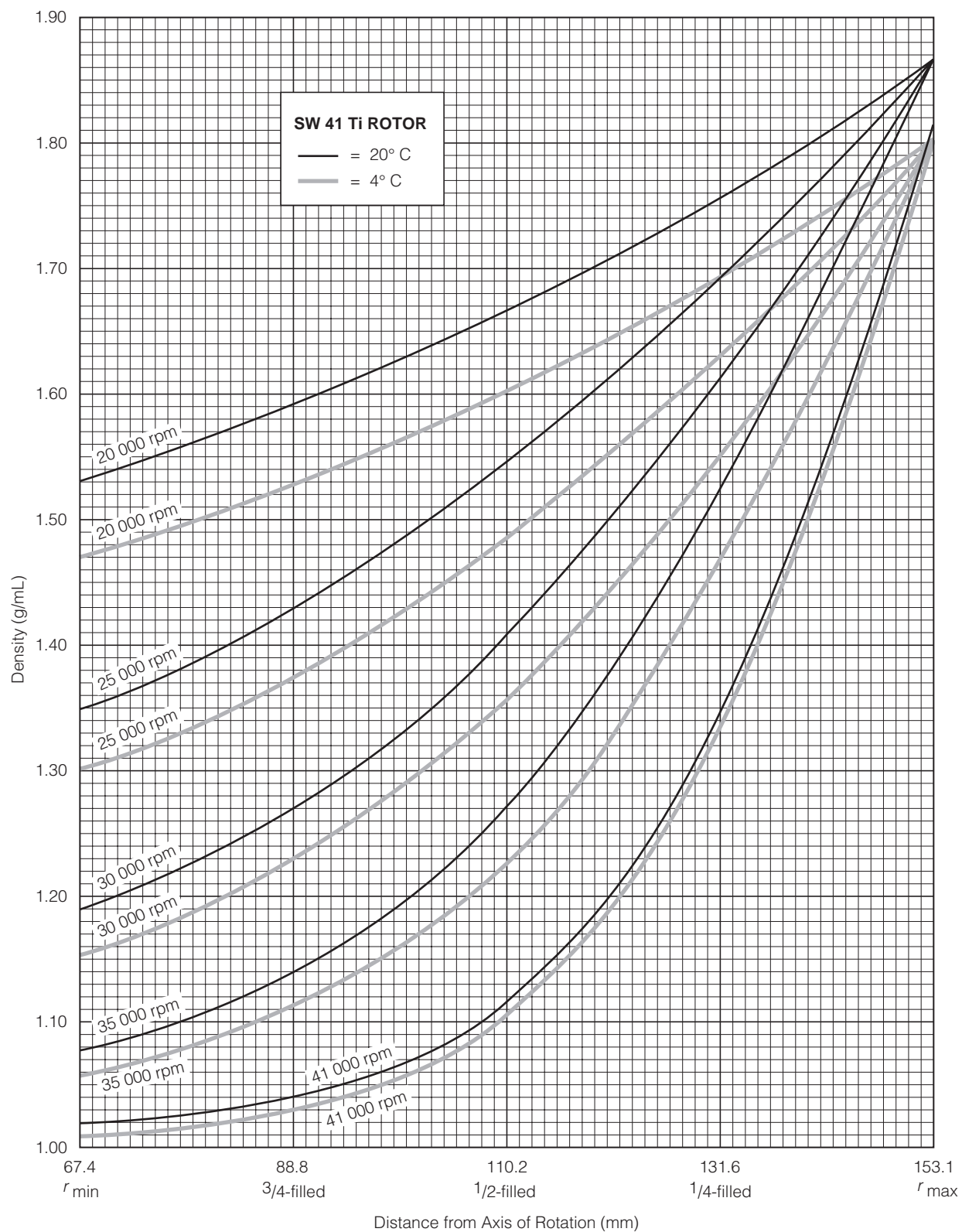
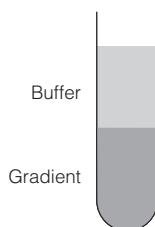

Figure 3. CsCl Gradients at Equilibrium for the SW 41 Ti Rotor. Centrifugation of homogeneous CsCl solutions at the maximum allowable speeds (from Figure 2) results in gradients presented here.

or from homogeneous solutions. But the total amount of CsCl in solution must be equivalent to a homogeneous solution corresponding to the concentrations specified in Figure 3.) Figure 3 can also be used to approximate the banding positions of sample particles. Curves not shown in the figure may be interpolated.

ADJUSTING FILL VOLUMES



Figures 2 and 3 show that several fill volumes are possible in a tube. If a thinwall tube is partially filled with gradient solution, float mineral oil (or some other low-density, immiscible liquid) on top of the tube contents to fill the tube to its maximum volume. (Do not use an oil overlay in Ultra-Clear tubes.) Note that for a given CsCl density, as the fill level decreases the maximum allowable speed increases. Partial filling may be desirable when there is little sample or when you wish to shorten the run time.

For example, a *quarter-filled* tube of 1.5-g/mL homogeneous CsCl solution at 4°C may be centrifuged at 41 000 rpm (see Figure 2). The segment of the 41 000-rpm curve (Figure 3) from the quarter-filled line to the tube bottom represents this gradient. The same solution in a *half-filled* tube may be centrifuged no faster than 33 000 rpm (curves not shown in the figure may be interpolated), and 28 000 rpm in a *three-quarter-filled* tube. A tube *full* of the 1.5-g/mL CsCl solution may be centrifuged no faster than 25 000 rpm.

TYPICAL EXAMPLES FOR DETERMINING CsCl RUN PARAMETERS

Example A: Starting with a homogeneous CsCl solution density of 1.6 g/mL and approximate particle buoyant densities of 1.69 and 1.72 g/mL, at 20°C, where will particles band at equilibrium?

1. In Figure 2, find the curve that corresponds to the required run temperature (20°C) and fill volume (one-half full). The maximum allowable rotor speed is determined from the point where this curve intersects the homogeneous CsCl density (30 000 rpm).
2. In Figure 3, sketch in a horizontal line corresponding to each particle's buoyant density.
3. Mark the point in the figure where each particle density intersects the curve corresponding to the selected run speed and temperature.

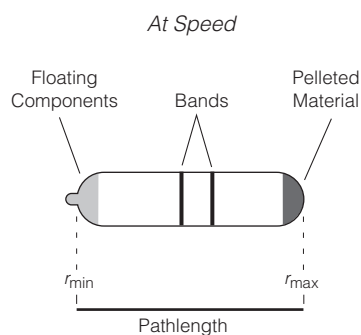

4. Particles will band at these locations across the tube diameter at equilibrium during centrifugation.

In this example, particles will band about 138 and 141.5 mm from the axis of rotation, about 3.5 mm of centerband-to-centerband separation.

To determine interband volume in milliliters, use the following equation:

$$V = \pi r^2 h \quad (7)$$

where r is the tube radius in centimeters and h is the interband separation in centimeters.

At Rest in Rotor



Example B: Knowing particle buoyant densities (for example, 1.36 and 1.42 g/mL), how do you achieve good separation?

1. In Figure 3, sketch in a horizontal line corresponding to each particle's buoyant density.
2. Select the curve at the required temperature (4°C) and tube volume (full) that gives the best particle separation.
3. Note the run speed along the selected curve (25 000 rpm).
4. From Figure 2, select the maximum homogeneous CsCl density (in this case, 1.5 g/mL) that corresponds to the temperature and run speed established above. These parameters will provide the particle-banding pattern selected in Step 2.

At Rest Outside Rotor



In this example, particles will band at about 85 and 97 mm from the axis of rotation (about 12 mm apart). The interband volume will be about 1.8 mL.

CARE AND MAINTENANCE

MAINTENANCE

NOTE

Do not use sharp tools on the rotor that could cause scratches in the rotor surface. Corrosion begins in scratches and may open fissures in the rotor with continued use.

Centering
Tool
(331325)

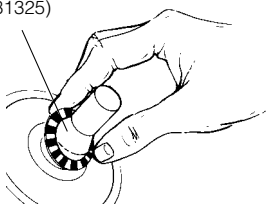

- Regularly inspect the overspeed disk on the bottom of the rotor adapter. If it is scratched, damaged, or missing, replace it. Replacement instructions are in Section 7 of *Rotors and Tubes*.
- Frequently check the bucket gaskets (331309) for signs of wear. Replace gaskets every 6 months, or whenever worn or damaged. Keep the gaskets lightly coated with silicone vacuum grease.
- Regularly lubricate the bucket cap threads with a thin, even coat of Spinkote lubricant (306812) before every run.

Refer to Appendix A in *Rotors and Tubes* for the chemical resistances of rotor and accessory materials. Your Beckman Coulter representative provides contact with the Field Rotor Inspection Program and the rotor repair center.

CLEANING



Rotor Cleaning
Kit (339558)

Wash the rotor and rotor components immediately if salts or other corrosive materials are used or if spillage has occurred. Do not allow corrosive materials to dry on the rotor.

Under normal use, wash the rotor frequently (at least weekly) to prevent buildup of residues.

1. Wash the rotor buckets, gaskets, and caps in a mild detergent, such as Beckman Solution 555™, that won't damage the rotor. The Rotor Cleaning Kit contains two plastic-coated brushes and two quarts of Solution 555 (339555) for use with rotors and accessories. Dilute the detergent 10 to 1 with water.
2. Wash the rotor body with a sponge or cloth dampened with a mild detergent, such as Beckman Solution 555, diluted 10 to 1 with water.

NOTE

Do not immerse the rotor body in water, since the hanger mechanism is difficult to dry and can rust.

3. Rinse the cleaned rotor and components with distilled water.
4. Air-dry the buckets upside down. *Do not use acetone to dry the rotor.*

Clean metal threads frequently to prevent buildup of residues and ensure adequate closure. Use a brush and concentrated Solution 555. Rinse and dry thoroughly, then lubricate lightly but evenly with Spinkote to coat all threads.

DECONTAMINATION



If the rotor or other components are contaminated with toxic, radioactive, or pathogenic materials, follow appropriate decontamination procedures as outlined by your laboratory safety officer. Refer to Appendix A in *Rotors and Tubes* to select solutions that will not damage the rotor and accessory materials.

STERILIZATION AND DISINFECTION

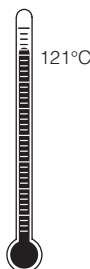

- The rotor and all rotor components can be autoclaved at 121°C for up to an hour. Remove the lids from the rotor buckets and place the rotor, buckets, lid, and spacers in the autoclave upside down.
- Ethanol (70%)* or hydrogen peroxide (6%) may be used on all rotor components, including those made of plastic. Bleach (sodium hypochlorite) may be used, but may cause discoloration of anodized surfaces. Use the minimum immersion time for each solution, per laboratory standards.

* Flammability hazard. Do not use in or near operating ultracentrifuges.

While Beckman Coulter has tested these methods and found that they do not damage the rotor or components, no guarantee of sterility or disinfection is expressed or implied. When sterilization or disinfection is a concern, consult your laboratory safety officer regarding proper methods to use.

Refer to publication IN-192 (included with each box of tubes) for tube sterilization and disinfection procedures. *Quick-Seal, Ultra Clear, and thinwall open-top tubes are disposable and should be discarded after a single use.*

STORAGE

When it is not in use, store the rotor in a dry environment (not in the instrument) with the bucket lids removed to allow air circulation so moisture will not collect in the tube cavities.

RETURNING A ROTOR

Before returning a rotor or accessory for any reason, prior permission (a Returned Goods Authorization form) must be obtained from Beckman Coulter, Inc. This RGA form may be obtained from your local Beckman Coulter sales office, and should contain the following information:

- serial number
- history of use (approximate frequency of use),
- reason for the return,
- original purchase order number, billing number, and shipping number, if possible,
- name and phone number of the person to be notified upon receipt of the rotor or accessory at the factory, and,
- name and phone number of the person to be notified about repair costs, etc.

To protect our personnel, it is the customer's responsibility to ensure that all parts are free from pathogens and/or radioactivity. Sterilization and decontamination must be done before returning the parts. Smaller items (such as tubes, bottles, etc.) should be enclosed in a sealed plastic bag.

*All parts must be accompanied by a note, plainly visible on the outside of the box or bag, stating that they are safe to handle and that they are not contaminated with pathogens or radioactivity. **Failure to attach this notification will result in return or disposal of the items without review of the reported problem.***

Use the address label printed on the RGA form when mailing the rotor and/or accessories to:

Beckman Coulter, Inc.
1050 Page Mill Road
Palo Alto, CA 94304

Attention: Returned Goods

Customers located outside the United States should contact their local Beckman Coulter office.

SUPPLY LIST

NOTE

To obtain copies of referenced publications, contact Beckman Coulter, Inc., Technical Publications Department, 1050 Page Mill Road, Palo Alto, CA 94304, U.S.A. (Telephone 650-859-1753; Fax 650-859-1375).

Call Beckman Coulter Sales (1-800-742-2345 in the United States; worldwide offices are listed on the back cover of this manual) or see the Beckman Coulter *Ultracentrifuge, Rotors, Tubes & Accessories* catalog (BR-8101, available at www.beckmancoulter.com) for detailed information on ordering parts and supplies. For your convenience, a partial list is given below.

REPLACEMENT ROTOR PARTS

SW 41 Ti rotor assembly	331362
Buckets (set of 6, with caps and gaskets)	333790
Bucket caps (set of 6)	331763
Bucket gasket	331309
Overspeed disk (41 000 rpm)	330335
Rotor stand	332400
Bucket holder rack	331313

OTHER

Tubes and accessories	see Table 1
Quick-Seal Cordless Tube Topper kit, 60 Hz	358312
Quick-Seal Cordless Tube Topper kit, 50 Hz (Europe)	358313
Quick-Seal Cordless Tube Topper kit, 50 Hz (Great Britain)	358314
Quick-Seal Cordless Tube Topper kit, 50 Hz (Australia)	358315
Quick-Seal Cordless Tube Topper kit, 50 Hz (Canada)	367803
Tube Topper rack (14-mm dia. tubes)	356568
Floating spacer removal tool	338765
Tube removal tool (Quick-Seal tubes)	361668
Extractor tool (konical tube adapters)	354468
Spinkote lubricant (2 oz)	306812
Silicone vacuum grease (1 oz)	335148
Rotor Cleaning Kit	339558
Beckman Solution 555 (1 qt)	339555
Rotor cleaning brush	339379
Centering tool (for overspeed disk replacement)	331325

ULTRACENTRIFUGE ROTOR WARRANTY

All Beckman Coulter ultracentrifuge Fixed Angle, Vertical Tube, Near Vertical Tube, Swinging Bucket, and Airfuge rotors are warranted against defects in materials or workmanship for the time periods indicated below, subject to the Warranty Conditions stated below.

Preparative Ultracentrifuge Rotors 5 years — No Proration

Analytical Ultracentrifuge Rotors 5 years — No Proration

ML and TL Series Ultracentrifuge Rotors 5 years — No Proration

Airfuge Ultracentrifuge Rotors 1 year — No Proration

For Zonal, Continuous Flow, Component Test, and Rock Core ultracentrifuge rotors, see separate warranty.

Warranty Conditions (as applicable)

- 1) This warranty is valid for the time periods indicated above from the date of shipment to the original Buyer by Beckman Coulter or an authorized Beckman Coulter representative.
- 2) This warranty extends only to the original Buyer and may not be assigned or extended to a third person without written consent of Beckman Coulter.
- 3) This warranty covers the Beckman Coulter Centrifuge Systems only (including but not limited to the centrifuge, rotor, and accessories) and Beckman Coulter shall not be liable for damage to or loss of the user's sample, non-Beckman Coulter tubes, adapters, or other rotor contents.
- 4) This warranty is void if the Beckman Coulter Centrifuge System is determined by Beckman Coulter to have been operated or maintained in a manner contrary to the instructions in the operator's manual(s) for the Beckman Coulter Centrifuge System components in use. This includes but is not limited to operator misuse, abuse, or negligence regarding indicated maintenance procedures, centrifuge and rotor classification requirements, proper speed reduction for the high density of certain fluids, tubes, and tube caps, speed reduction for precipitating gradient materials, and speed reduction for high-temperature operation.
- 5) Rotor bucket sets purchased concurrently with or subsequent to the purchase of a Swinging Bucket Rotor are warranted only for a term co-extensive with that of the rotor for which the bucket sets are purchased.
- 6) This warranty does not cover the failure of a Beckman Coulter rotor in a centrifuge not of Beckman Coulter manufacture, or if the rotor is used in a Beckman Coulter centrifuge that has been modified without the written permission of Beckman Coulter, or is used with carriers, buckets, belts, or other devices not of Beckman Coulter manufacture.
- 7) Rotor parts subject to wear, including but not limited to rotor O-rings, VTi, NVT™, TLV, MLN, and TLN rotor tube cavity plugs and gaskets, tubing, tools, optical overspeed disks, bearings, seals, and lubrication are excluded from this warranty and should be frequently inspected and replaced if they become worn or damaged.
- 8) Keeping a rotor log is not mandatory, but may be desirable for maintenance of good laboratory practices.

Repair and Replacement Policies

- 1) If a Beckman Coulter rotor is determined by Beckman Coulter to be defective, Beckman Coulter will repair or replace it, subject to the Warranty Conditions. A replacement rotor will be warranted for the time remaining on the original rotor's warranty.
- 2) If a Beckman Coulter centrifuge is damaged due to a failure of a rotor covered by this warranty, Beckman Coulter will supply free of charge (i) all centrifuge parts required for repair (except the drive unit, which will be replaced at the then current price less a credit determined by the total number of revolutions or years completed, provided that such a unit was manufactured or rebuilt by Beckman Coulter), and (ii) if the centrifuge is currently covered by a Beckman Coulter warranty or Full Service Agreement, all labor necessary for repair of the centrifuge.
- 3) If a Beckman Coulter rotor covered by this warranty is damaged due to a malfunction of a Beckman Coulter ultracentrifuge covered by an Ultracentrifuge System Service Agreement, Beckman Coulter will repair or replace the rotor free of charge.
- 4) If a Beckman Coulter rotor covered by this warranty is damaged due to a failure of a Beckman Coulter tube, bottle, tube cap, spacer, or adapter, covered under the Conditions of this Warranty, Beckman Coulter will repair or replace the rotor and repair the instrument as per the conditions in policy point (2) above, and the replacement policy.
- 5) Damage to a Beckman Coulter rotor or instrument due to the failure or malfunction of a non-Beckman Coulter tube, bottle, tube cap, spacer, or adapter is not covered under this warranty, although Beckman Coulter will assist in seeking compensation under the manufacturer's warranty.

Disclaimer

IT IS EXPRESSLY AGREED THAT THE ABOVE WARRANTY SHALL BE IN LIEU OF ALL WARRANTIES OF FITNESS AND OF THE WARRANTY OF MERCHANTABILITY AND BECKMAN COULTER, INC. SHALL HAVE NO LIABILITY FOR SPECIAL OR CONSEQUENTIAL DAMAGES OF ANY KIND WHATSOEVER ARISING OUT OF THE MANUFACTURE, USE, SALE, HANDLING, REPAIR, MAINTENANCE, OR REPLACEMENT OF THE PRODUCT.

Factory Rotor Inspection Service

Beckman Coulter, Inc., will provide free mechanical and metallurgical inspection in Palo Alto, California, USA, of any Beckman Coulter rotor at the request of the user. (Shipping charges to Beckman Coulter are the responsibility of the user.) Rotors will be inspected in the user's laboratory if the centrifuge in which they are used is covered by an appropriate Beckman Coulter Service Agreement. Contact your local Beckman Coulter office for details of service coverage or cost.

Before shipping, contact the nearest Beckman Coulter Sales and Service office and request a Returned Goods Authorization (RGA) form and packaging instructions. Please include the complete rotor assembly, with buckets, lid, handle, tube cavity caps, etc. A SIGNED STATEMENT THAT THE ROTOR AND ACCESSORIES ARE NON-RADIOACTIVE, NON-PATHOGENIC, NON-TOXIC, AND OTHERWISE SAFE TO SHIP AND HANDLE IS REQUIRED.

Beckman Coulter Worldwide Life Science Research Division Offices

AUSTRALIA

Beckman Coulter Australia Pty Ltd
Unit D, 24 College St.
Gladesville, NSW 2111
Australia
Telephone: (61) 2 9844-6000
or toll free: 1 800 060 880
Fax: (61) 2 9844-6096
email: lifescienceaustralia@beckman.com

CANADA

Beckman Coulter (Canada) Inc.
6755 Mississauga Road, Suite 600
Mississauga, Ontario
Canada L5N 7Y2
Telephone: (905) 819-1234
Fax: (905) 819-1485

CHINA

Beckman Coulter Inc.
Beijing Representative Office
Unit 2005A, 2006-2009, East Ocean Center
Jian Guomenwai Avenue
Beijing 100004
China
Telephone: (86) 10 6515 6028
Fax: (86) 10 6515 6025, 6515 6026

EASTERN EUROPE/ MIDDLE EAST/NORTH AFRICA

Beckman Coulter International S.A.
22, Rue Juste-Olivier
Case Postale 301-303
CH-1260 Nyon, Switzerland
Telephone: (41) 22 994 07 07
Fax: (41) 22 994 07 00

FRANCE

Beckman Coulter France S.A.
Paris Nord II, 33/66 rue des Vanesses
B.P. 50359
Villepinte, France
95942 ROISSY CDG Cedex
Telephone: 01 49 90 90 00
Fax: 01 49 90 90 10
e-mail: bioresearch.france@beckman.com

GERMANY

Beckman Coulter GmbH
Siemensstrasse 1
D-85716 Unterschleissheim-Lohhof
Germany
Telephone: (89) 35870-0
Fax: (89) 35870-490
e-mail: bioresearch.de@beckman.com

HONG KONG

Beckman Coulter Hong Kong Ltd.
12th Floor, Oxford House
979 King's Road
Taikoo Place, Hong Kong
Telephone: (852) 2814 7431, 2814 0481
Fax: (852) 2814 1599, 2873 4511

ITALY

Beckman Coulter S.p.a.
Centro Direzionale Lombardo
Palazzo F/1, Via Roma 108
20060 Cassina de' Pecchi
Milano, Italy
Telephone: 02-953921
Fax: 02-95392264

JAPAN

Beckman Coulter K.K.
Toranomon 37 Mori Bldg.
3-5-1, Toranomon
Minato-ku, Tokyo 105-0001
Japan
Telephone: 03-5404-8359
Fax: 03-5404-8436

MEXICO

Beckman Coulter de Mexico S.A. DE C.V.
Avenida Popocatepetl #396
Colonia Gral. Pedro Maria Anaya
Codigo Postal 03340
Maxico, D.F. / Mexico City
Telephone: 525 605-77-70
Fax: 525 575-18-25

NETHERLANDS

Beckman Coulter Nederland B.V.
Nijverheidsweg 21
3641 RP-Mijdrecht
Postbus 47
3640 AA Mijdrecht
The Netherlands
Telephone: 0297-230630
Fax: 0297-288082

SINGAPORE

Beckman Coulter Singapore Pte. Ltd.
116 Changi Road
Unit #03-01/02
Singapore 419718
Telephone: (65) 6339 3633
Fax: (65) 6336 6303

SOUTH AFRICA/SUB-SAHARAN AFRICA

Beckman Coulter
Stand 1A Primegro Park
Tonetti Street
1685 Halfway House
Johannesburg
Republic of South Africa
Telephone: (27) 11-805-2014/5
Fax: (27) 11-805-4120
e-mail: beckman@intekom.co.za

SPAIN

Beckman Coulter España S.A.
C/ Caleruega, 81
28033 Madrid, Spain
Telephone: (34) 91 3836080
Fax: (34) 91 3836096
email: bioresearch.espana@beckman.com

SWEDEN

Beckman Coulter AB
Archimedesvaegen 7
Box 111 56
SE-168 11 Bromma
Sweden
Telephone: (0)8 564 85 900
Telefax: (0)8 564 85 901

SWITZERLAND

Beckman Coulter International S.A.
22, Rue Juste-Olivier
Case Postale 301-303
CH-1260 Nyon
Switzerland
Telephone: 0800 850 810
Fax: 0848 850 810

TAIWAN

Beckman Coulter Taiwan Inc.
Taiwan Branch
8th Floor
216 Tun Hwa South Road, Section 2
Taipei 106, Taiwan
Republic of China
Telephone: (886) 2 2378 3456
Fax: (886) 2 2377 0408

TURKEY

Beckman Coulter Ltd.
E-5 Yanyol Faith Cad.
81410 Soganlik Kartal
Istanbul
Turkey
Telephone: 90 216 309 1900
Fax: 90 216 309 0090

UNITED KINGDOM

Beckman Coulter United Kingdom Ltd
Oakley Court
Kingsmead Business Park
London Road
High Wycombe
Buckinghamshire HP11 1JU
England, U.K.
Telephone: 01494 441181
Fax: 01494 447558
e-mail: beckman_uk@beckman.com

Authorized dealers in other countries.



Beckman Coulter, Inc. • 4300 N. Harbor Boulevard, Box 3100 • Fullerton, California 92834-3100
Sales: 1-800-742-2345 • Service: 1-800-551-1150 • Internet: www.beckmancoulter.com • Telex: 678413 • Fax: 1-800-643-4366



Printed on recycled paper

©2002 Beckman Coulter, Inc.



I.S. EN ISO 9001